

Highly scalable, highly modular:
safe automation with TwinSAFE

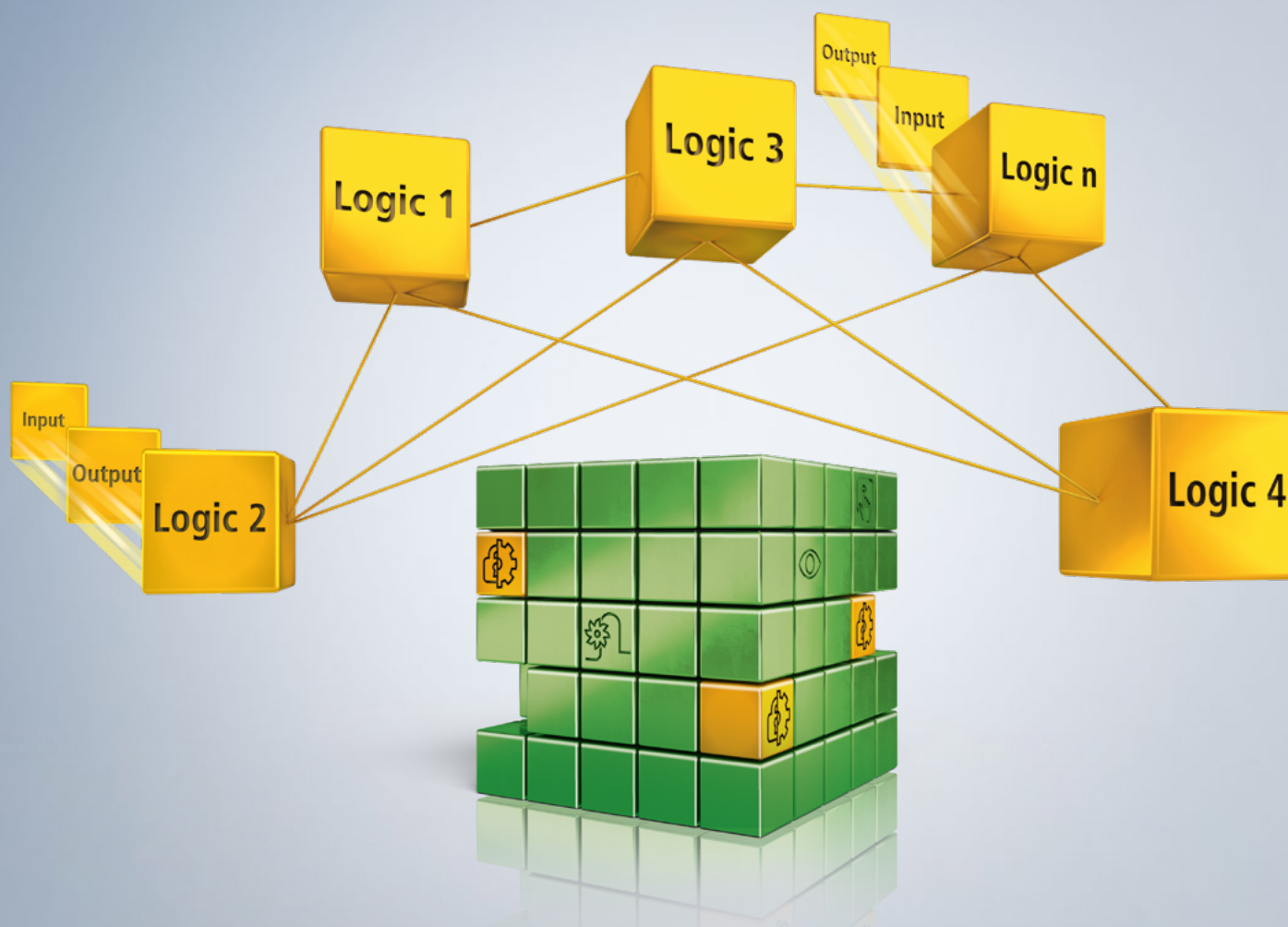

TwinSAFE integrates automation and safety on one platform

A winning edge with Beckhoff Control:

- all functions on one platform
- high-performance control solution
- high-performance EtherCAT fieldbus
- modular and scalable

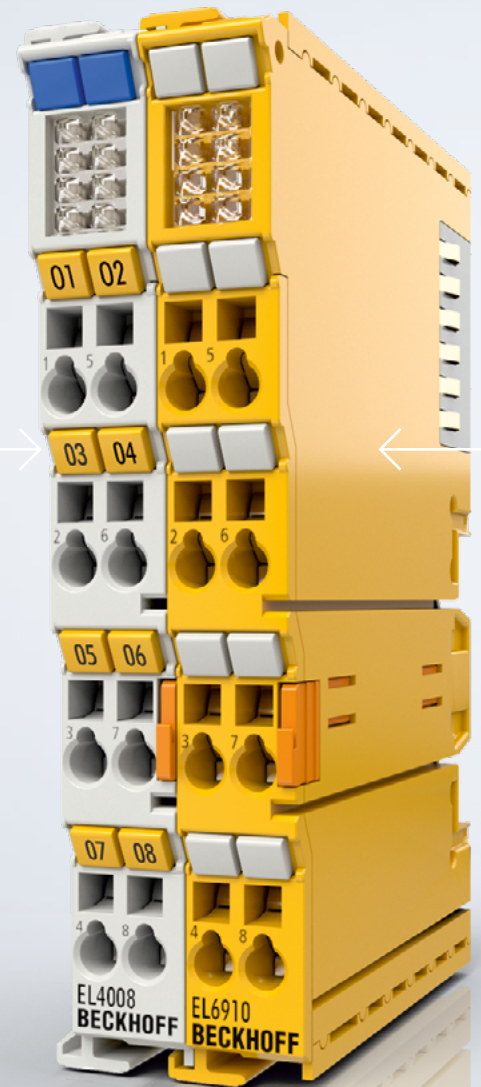

Industrial PC



I/O



Motion



Automation

Beckhoff implements open automation systems on the basis of PC-based control technology – including safety.

Safety and non-safety are converging

As a specialist for PC-based control, Beckhoff enables especially simple implementation of all required safety standards through direct integration into the Beckhoff control system. This is based on a comprehensive, highly scalable and modular automation portfolio, extending to all components from IPC to I/O, motion and software. All functionalities can be integrated into the overall control system with this portfolio – from HMI to measurement technology, IoT, vision, PLC and motion through to safety. Safety can therefore be integrated seamlessly with considerably reduced effort, because machine builders

A winning edge with Beckhoff Safety:

- system-integrated safety functionality
- free choice of architecture
- comprehensive safety expertise
- open communication

are gaining access to a uniform tool base and hardware platform. System integration can be realised in all application areas with TwinSAFE, effectively ending the historically strict separation of "safety" and "non-safety". At the same time, TwinSAFE impresses through ultimate flexibility and scalability. All safety features can be integrated in any conceivable machine architecture – from stand-alone control to compact control and the "traditional" solution through to distributed control and software-based control, which allows even the most complex requirements to be fulfilled. End users can therefore obtain a complete safety package tailored to their needs, while

unnecessary costs for overdimensioned safety solutions are avoided. Machine builders and users will benefit from the extensive and long-standing safety expertise provided by Beckhoff. The full wealth of safety know-how is available in-house with Beckhoff and is drawn on for customers in every individual TwinSAFE solution. The focus is on the principle of openness, as is typical of Beckhoff technology. On the one hand, the safe communication protocol Safety over EtherCAT (FSoE, Fail Safe over EtherCAT) is internationally certified and on the other hand there are no restrictions regarding transmission media.

Your winning edge through complete integration:

- consistency: everything from one source
- connectivity: all information is available in one integrated system
- adaptability: modularity and scalability allow simple adaptation to current and future requirements

Complete: the right solution in all application areas



Engineering

With the TwinCAT Safety Editor and other additional tools, TwinSAFE provides resources for creating an optimum safety solution intuitively and flexibly.



Control

High-performance TwinSAFE safety controllers are available in all form factors to support every type of safety application.

TwinSAFE – the cross-sectional solution

Non-safety related automation technology from Beckhoff can essentially be divided into four categories, that is, IPC (control), I/O (input and output), motion (drive technology) and automation (software). These components can be used to realise the most comprehensive range of automation tasks. As the complexity of non-safety related control functions continues to grow, the requirements with respect to safety technology are increasing in the same way. Modern safety technology therefore covers a very broad range of tasks, with appropriate safety solutions required in all areas of automation. TwinSAFE offers

the right solution in all application areas. A broad range of components equipped with TwinSAFE Logic means full freedom in terms of choosing an architecture for the safety application at hand. In terms of I/O components, the TwinSAFE system offers an appropriate choice of safe input, output and mixed components, allowing the solution to be easily adapted to the specific requirements. The broad range of TwinSAFE components for all requirements includes the EtherCAT Terminals for control cabinet installation, the EtherCAT Box modules for use directly in the field and the EtherCAT plug-in modules for use in series machines.



I/Os

Similarly to the standard I/Os, safe input and output modules are available in the most varied granularity to allow optimum adaptation to any individual requirements.



Motion

High-performance TwinSAFE components for motion control can be used to realise safety technology drive functions.

In the area of drive technology, too, solutions are scarcely conceivable any more without safety functionality. Beckhoff has therefore integrated safety functionalities in its drive solutions early on, both into standard and compact drive technology.

In the area of engineering, the safety and non-safety tools from Beckhoff have already merged, enabling a universal configuration and programming of all applications. With a graphical editor, the TwinCAT Safety Editor simplifies the implementation of safety applications by means of certified function blocks. A certified application

manual makes the engineering process even more straightforward from conceptual design through to realisation.

Flexible implementation of safety solutions with TwinSAFE:

- comprehensive software support
- high-performance safety controllers in various form factors
- safety components for different environmental conditions
- safety components in the most diverse granularities for optimum adaptability

Safety-over-EtherCAT: Open for all

Safety over
EtherCAT®  **01001**
0100110

Safe

Standardised

Fieldbus-neutral

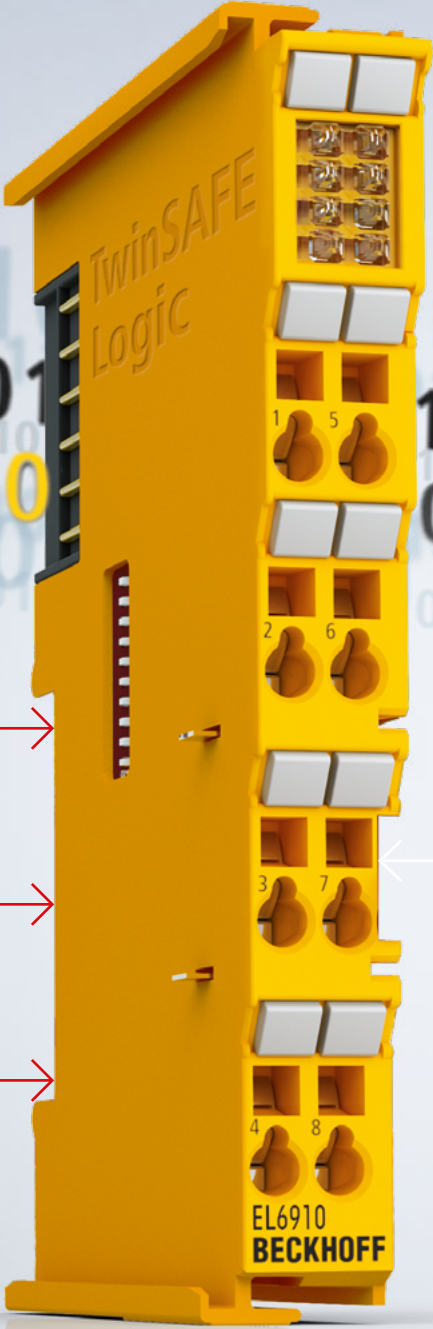

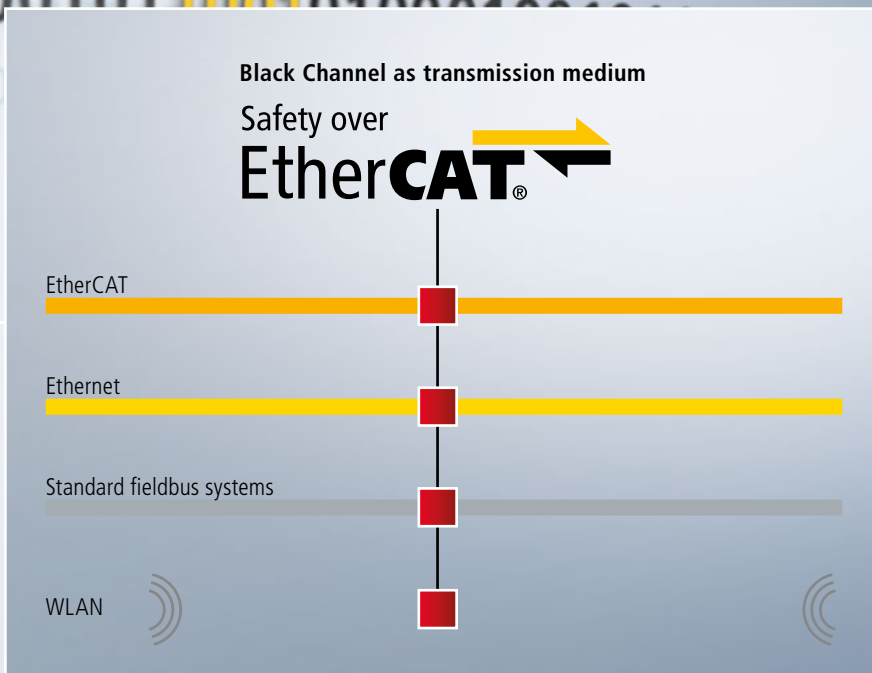

The Safety-over-EtherCAT (FSoE, Fail Safe over EtherCAT) protocol defines open, secure data transmission. The technology certified by TÜV is internationally standardised according to IEC 61784-3 and fulfils the safety requirements specified by IEC 61508 up to the SIL 3 safety level. The transport medium is considered as a "black channel" in Safety-over-EtherCAT communication, meaning that the FSoE protocol can be transmitted using any communication technologies – over EtherCAT or Ethernet, but also via standard fieldbus systems such as CAN and also over wireless networks. FSoE is an ideal complementation of the open EtherCAT technology

and guarantees high-performance transmission of control and safety information via the same communication system.

Benefits of the highly flexible communication system:

- flexibility through transmission via any media
- flexibility through the large number of component vendors

TwinSAFE: Logic in all components

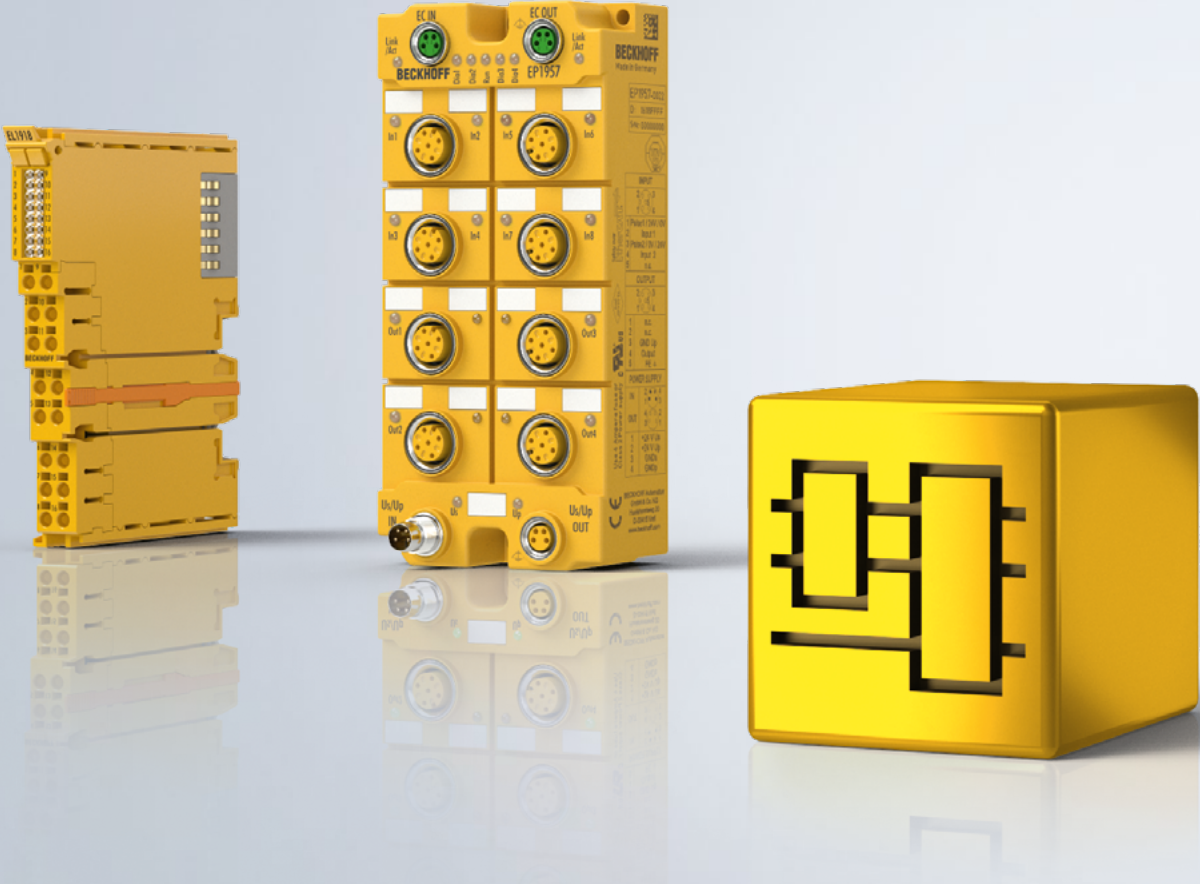

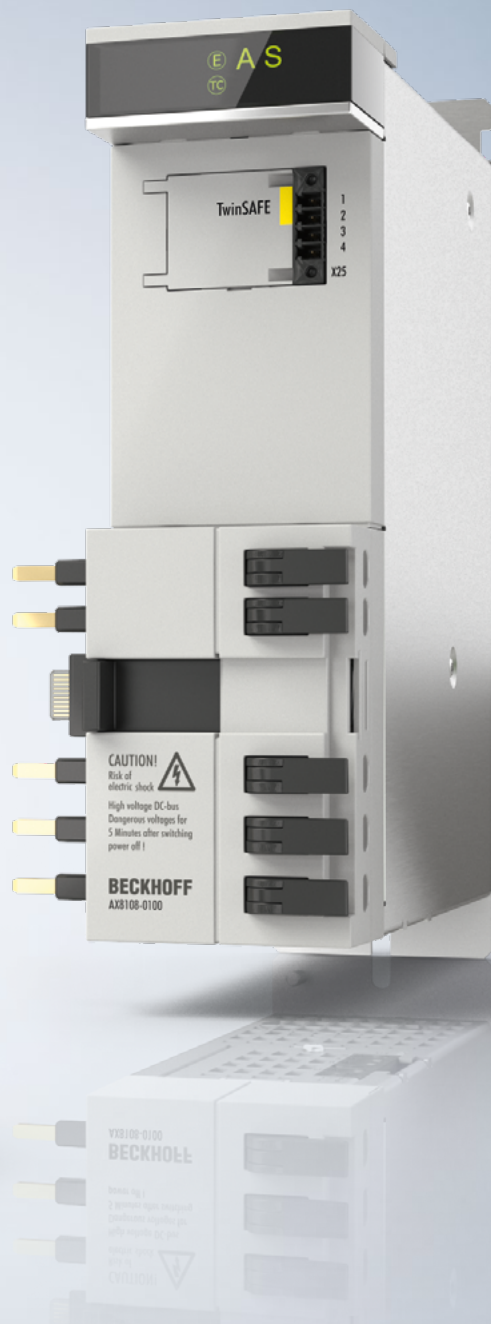

With the introduction of the new Logic generation (from EL6910 on), Beckhoff has triggered a revolution in safety technology. The functionality of the TwinSAFE Logic is integrated in all new TwinSAFE components, thus considerably extending the range of potential deployment and application scenarios. TwinSAFE is becoming significantly more flexible in terms of adaption to individual safety requirements of a machine. For example, the integrated TwinSAFE Logic functionality in a digital input component (e.g. EL1918) can be used to selectively preprocess sensor data directly on the component. This preprocessing function can be developed separately and likewise verified and

validated separately. If a central safety controller – central from a safety technology perspective – exists, it therefore only has to process the resulting sensor data. Special knowledge for ensuring proper preprocessing is then no longer needed, reducing the complexity of the centralised safety application and in turn simplifying validation and verification of the centralised safety application. In addition to this “simple” application for preprocessing data, the safety option can also be used, for example, within a multi-axis AX8000 servo system to control a complete axis group from a safety technology perspective, while a central safety controller is used to control the overall axis group.

Application scenarios of the integrated Logic:

- specific preprocessing of signals directly by input components
- fast local responses through localised safety applications
- efficient and flexible modularisation without additional costs

Individually scalable: the TwinSAFE architectures

TwinSAFE gives machine builders the possibility to realise the most diverse safety architectures with components in different form factors – from stand-alone control to distributed control, including preprocessing of data directly by I/O terminals, through to system-integrated software-based control for highly complex safety applications. Customers have the benefit of attractively priced, flexible and optimally scalable solutions – and the certainty of being able to meet all safety requirements as needed at all times and in the future, too.



Stand-alone control

Beckhoff supplies components for the TwinSAFE applications, which can be operated in stand-alone mode or, in other words, without being connected to an EtherCAT master. A limited local safety application can be realised very easily in this way.

Page 12



Compact control

In the introduction of the new Logic generation, Beckhoff is supplying every new TwinSAFE component with Logic functionality, just as with the EL6910 before. Single components can be used to realise compact safety applications. Apart from implementing fully functional safety applications, these components can also be used for input data preprocessing directly by the input component, for example.

Page 14



= Safety Logic

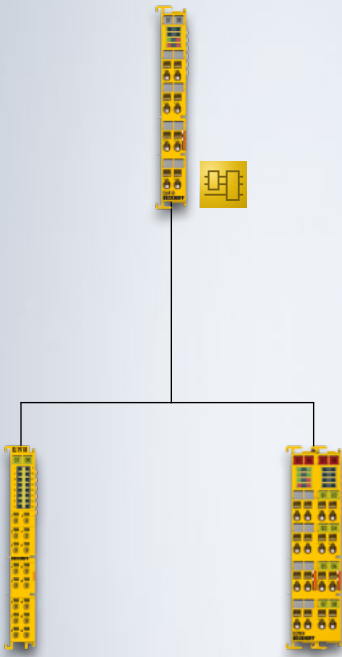

Centralised control

Centralised control solutions correspond to the traditional safety architecture. A dedicated safety controller, which is centralised from a safety technology perspective, communicates with 1...n communication participants. All safety-related data is processed by this central safety controller.

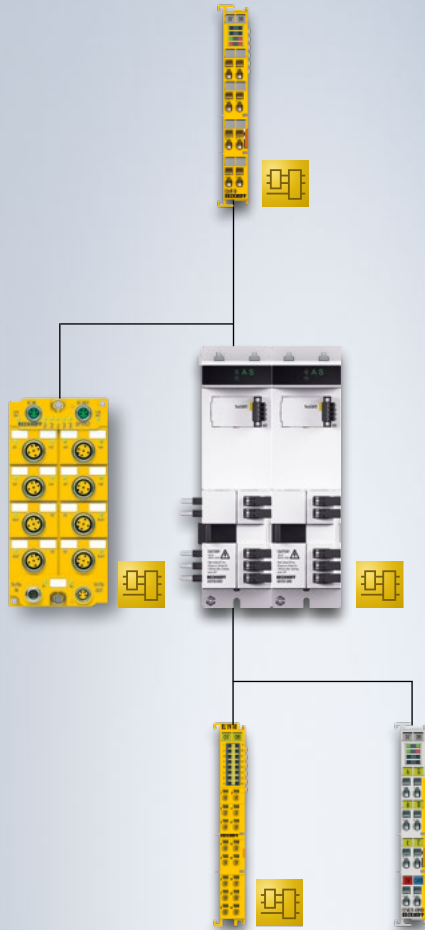

Distributed control

TA distributed control architecture allows any desired form of modularisation to be implemented in a safety application. The safety project can be freely distributed across a number of logic-capable components as required. The safety projects assigned to the single components can then be developed, validated and verified independently of each other. Communication between the components complies with user-specified interfaces.

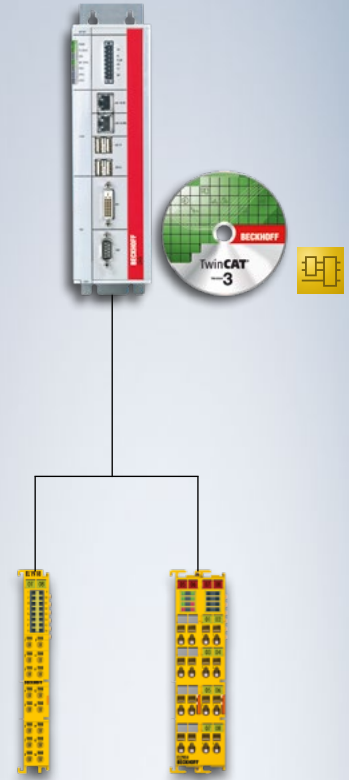

Software-based control

The software control architecture uses the TwinCAT Safety PLC, a software-based safety controller, as a central component. This architecture is mainly intended for highly complex safety applications beyond the functional scope of the hardware-based TwinSAFE Logic components, which can only be programmed using function block diagram language.

Compact: TwinSAFE stand-alone controllers

EK1960



TwinSAFE Logic



EK1960



Standard control system and I/Os



EP1957-0022

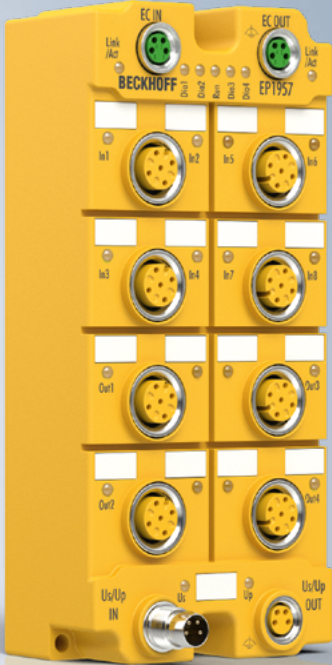

TwinSAFE as a stand-alone controller
With the rollout of the two components EK1960 and EP1957, TwinSAFE offers a safety solution for compact applications. These devices can be operated in stand-alone mode without connection to the EtherCAT fieldbus. The safety application is realised on the basis of the safe local inputs and outputs. The stand-alone-capable components can of course also be used, as usual, when fully integrated into the overall system.



Locally integrated: TwinSAFE compact controllers

EK1960



EJ1957



TwinSAFE Logic



EL2911



Standard control system and I/Os

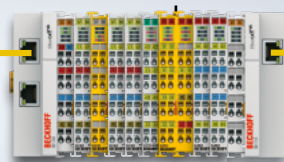

EL1957

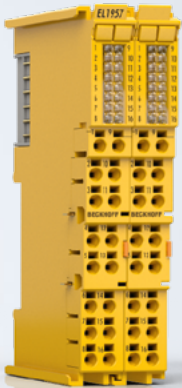

EL2911

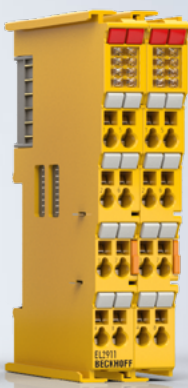

EP1957-0022

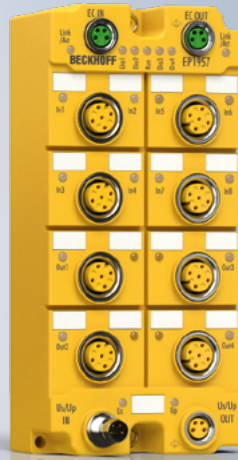

AX8108-0100

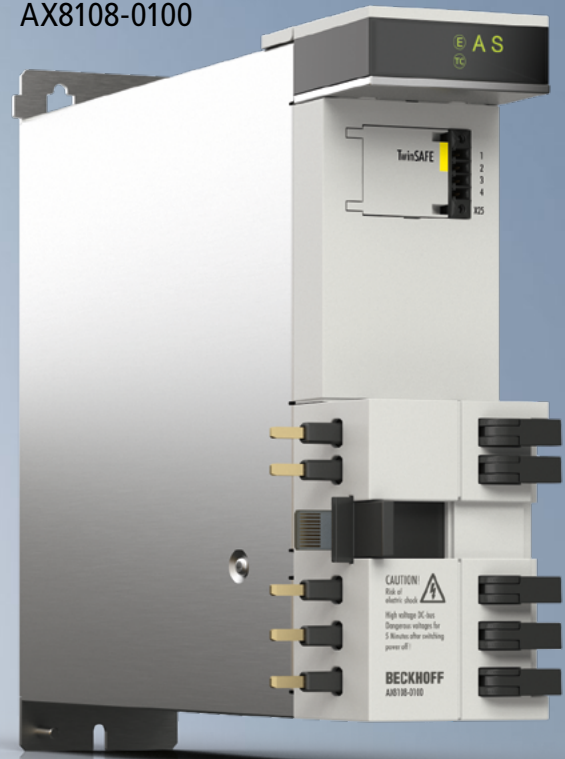

TwinSAFE as a compact controller

With the integration of the TwinSAFE Logic functionality into all new TwinSAFE components and therefore also into all TwinSAFE I/O components, the potential range of applications for TwinSAFE is significantly extended. In this way, an individual component with local inputs and outputs can be used to realise a safety application (EL1957). As with all TwinSAFE Logic components, communication with existing TwinSAFE components is also possible. In addition to the components represented here, which have both local inputs and local outputs, pure input or output components are also available with TwinSAFE Logic.



For traditional architectures: centralised safety controllers

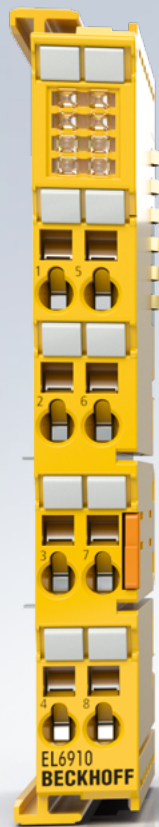

EL6910

EJ6910

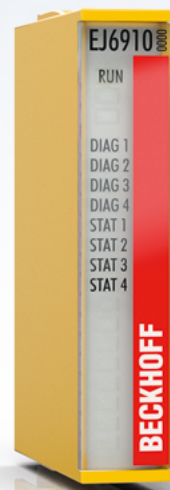

TwinSAFE Logic

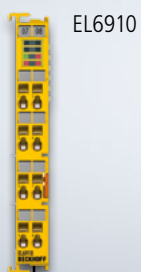

Standard control system and I/Os

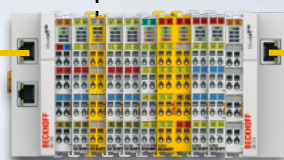

EL6900



EL6930

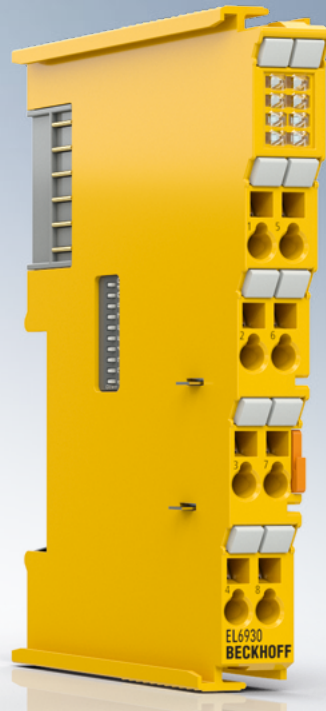

TwinSAFE as a central safety controller

TwinSAFE provides dedicated safety controllers, which can be used for centralised control from a safety technology perspective. These devices themselves do not have local inputs and outputs. Instead, communication relationships are established with 1...n safety-related components, and the safe input and output signals are processed in accordance with the user-defined safety application. The architecture in this case corresponds to the traditional architecture of safety applications. In addition to the dedicated safety controllers represented here, all Logic-capable components can of course also be used in context with a conventional architecture.



Stay flexible: freely distributed safety applications

EL1918, EL6910, EL2911, EL1957, EL2912



EP1957-0022

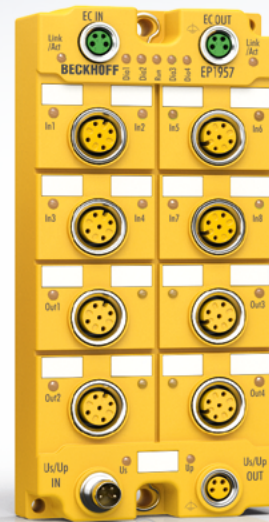

EJ6910, EJ1914, EJ2914



TwinSAFE Logic



EL6910 EL2911

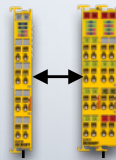

EK1960



Standard control system and I/Os

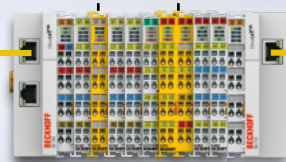

AX8108-0100



EJ1918, EJ2918, EJ1957



EK1960

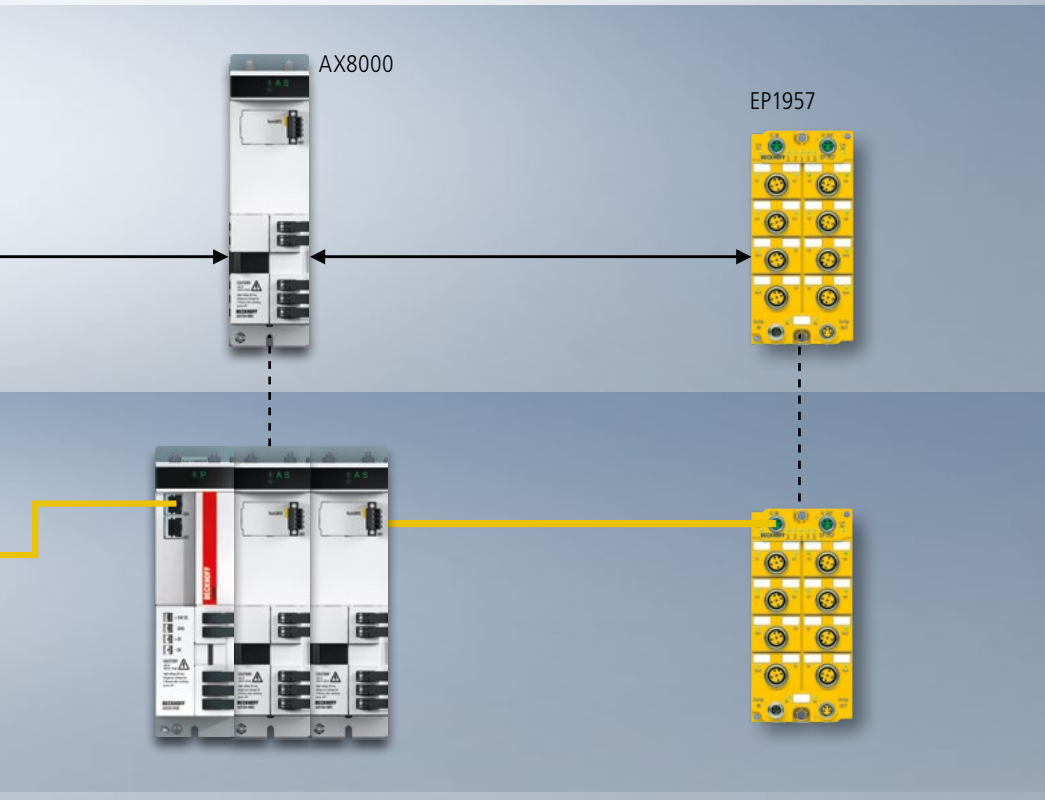
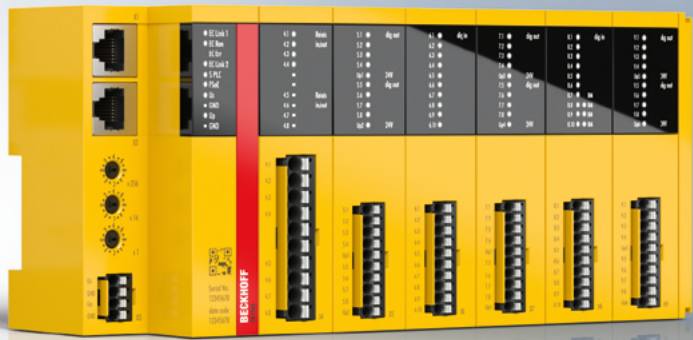

TwinSAFE as a distributed system

Through the integration of the TwinSAFE Logic functionality into all new TwinSAFE components, any distribution or modularisation of a safety application can be realised. In contrast to the traditional architecture, not all safety-related input and output signals have to be transmitted for processing to the central safety controller. The options of distributed control means that, from a safety technology perspective, functionally related components can be modelled by a dedicated safety project. If a system involves an AX8000 group with n modules, for example, where each of these n modules also has to execute safety-related drive functions, then, in the traditional approach, these drive functions have to be controlled individually by the central safety controller. Through the principle of distributed control, on the other hand, one of the modules can now be used as a TwinSAFE Logic, which locally takes over the safety-related control of the other TwinSAFE modules in the group.

For highly complex safety applications: more performance with IPC



TwinSAFE Logic



Standard control system and I/Os

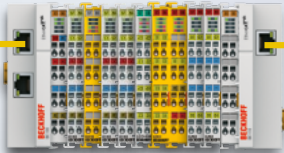

CX5120



Safety control with the standard IPC:

With the introduction of the TwinCAT Safety PLC software, TwinSAFE can leverage the enormous performance of standard Industrial PCs in safety control applications. Using an IPC as a software safety controller, even the most sophisticated safety applications can be executed. With the TwinCAT Safety PLC used in a traditional architecture, the overall system is controlled by a single, centralised device, which realises both the standard functionality and the safety functionality. In contrast to the TwinSAFE hardware components, this safety controller can also be programmed in a standard C derivative with Safety C. This means that safety applications with any level of complexity can be represented. As is typical with TwinSAFE, this architecture can be combined as required with other TwinSAFE architectures.



For analog safety solutions: TwinSAFE SC



Sample application from the application manual

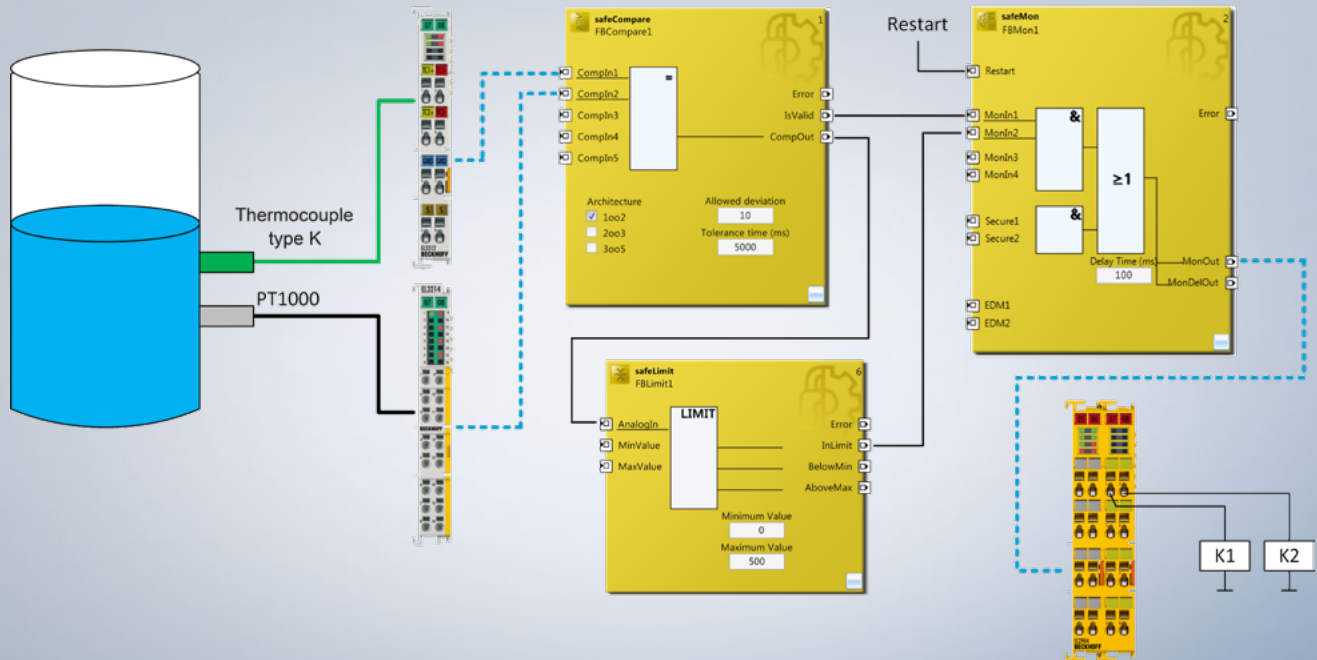

The example shows how temperature measurement can be performed using TwinSAFE SC technology. Two measurement points are fitted with diverse temperature sensors. One of the signals is transmitted via TwinSAFE SC to the safety controller for plausibility checking with the aid of the second signal.

TwinSAFE SC technology (TwinSAFE Single Channel) allows the use of standard signals for safety-relevant tasks in any networks or field-bus systems. EtherCAT I/Os with functions such as analog inputs, angle/path measurement or communication (4...20 mA, incremental encoder, IO-Link, etc.) are extended for this purpose by the TwinSAFE SC function, with the typical signal properties and standard functionalities of the I/O components being preserved. TwinSAFE SC I/Os differ visually from standard I/Os by a yellow stripe on the front of the housing.

TwinSAFE SC technology allows communication via a TwinSAFE protocol. These connections can be distinguished from the usual safe communication over Safety-over-EtherCAT.

The data of the TwinSAFE SC components is routed via a TwinSAFE protocol to the TwinSAFE logic and can be used there in the context of safety-related applications. Detailed examples concerning the correct use of the TwinSAFE SC components and the relevant normative classification, which have been calculated and confirmed by German authorities TÜV SÜD, can be referenced in the TwinSAFE application manual.

Benefits of TwinSAFE SC:

- economic use of standard signals in safety applications
- simple expansion of existing systems by safe analog value processing

... and also for complex applications

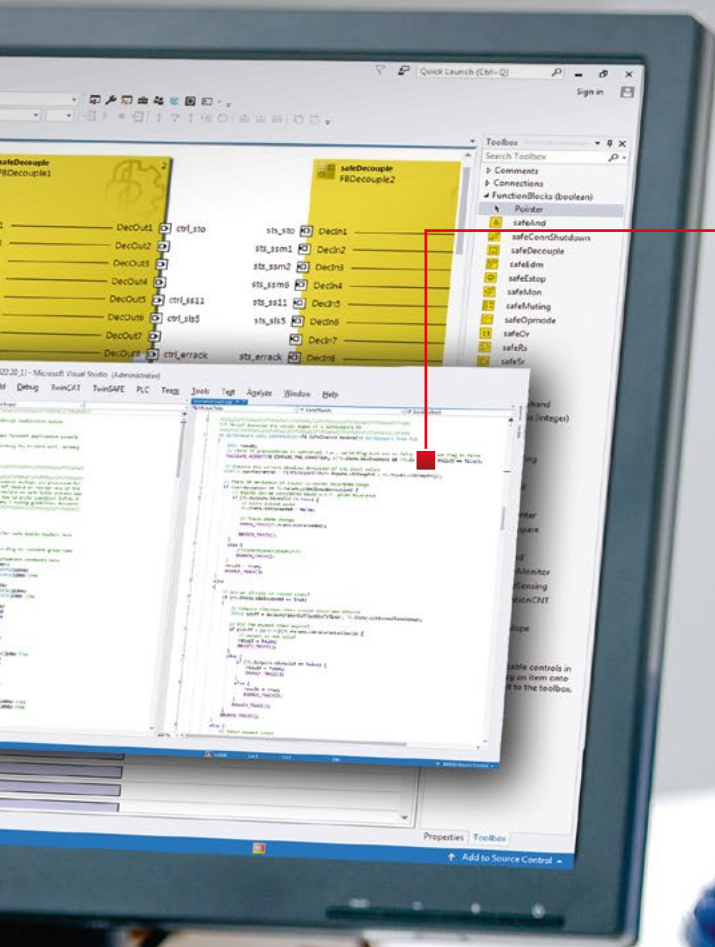

With Safety C

The programming of highly complex safety applications is possible with Safety C. Safety C is a derivative of Standard C and allows free programming of the desired safety application in the TwinCAT 3 environment.

Programming with function blocks

All hardware components with integrated TwinSAFE Logic can be programmed based on certified function blocks. The certified safety function blocks of the TwinSAFE Logic components allow simple, fault-free and cost-effective realisation of all safety tasks – from simple safety door monitoring to complex muting functions based on digital signals through to safe control of highly complex processes based on analog signals.

Programming with Safety C

Highly complex safety applications with the software-based TwinCAT Safety PLC can be programmed with Safety C. Safety C represents a derivative of Standard C. In order to increase safety, restrictions can be made, for example, in terms of strict type identification, implicit type casting and others. Otherwise, all control constructs familiar from Standard C, for example, can be used to realise a safety application. Auxiliary libraries are available that further simplify the engineering process.

Flexible programming options:

- selection of programming language depending on requirements
- intuitive programming for safety-related basic functionalities
- free programming in high-level language for highly complex safety applications

Simple adaptation, high-performance tools: the engineering highlights

Customizing

Safety technology subgroups can be configured within a safety application, which can then be permanently or temporarily deactivated or switched to passive mode during runtime, thus allowing a machine to be adapted with ultimate flexibility to the prevailing requirements in each case.

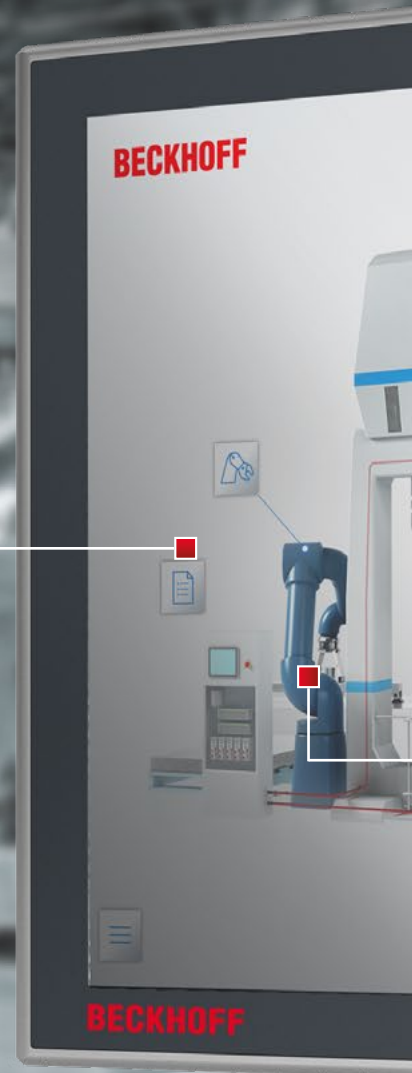

Customizing

The customizing functionality is one of the most significant innovations in the new generation of safety controllers. Safety projects can still be modularly designed, and apart from that the customizing function allows the following operating modes to be configured for each of these modules:

- temporary deactivation
- permanent deactivation
- passivation

These settings along with the corresponding configuration of replacement values for the interfaces between the different modules allow highly complex modular and scalable architectures to be implemented. A single safety project can thus be used for a whole series of machines, for example. When it comes to smaller variants of a machine, the modules not needed in each case can be simply deactivated, which of course is enormously beneficial in terms of development costs as only one safety project has to be developed, validated and verified in compliance with normative requirements. Switching between the various operating modes is possible during runtime.

The Beckhoff engineering provides two different options for this, with the modules being adapted to the current machine requirements either via the TwinCAT 3 development environment or else using the TwinSAFE Loader tool.

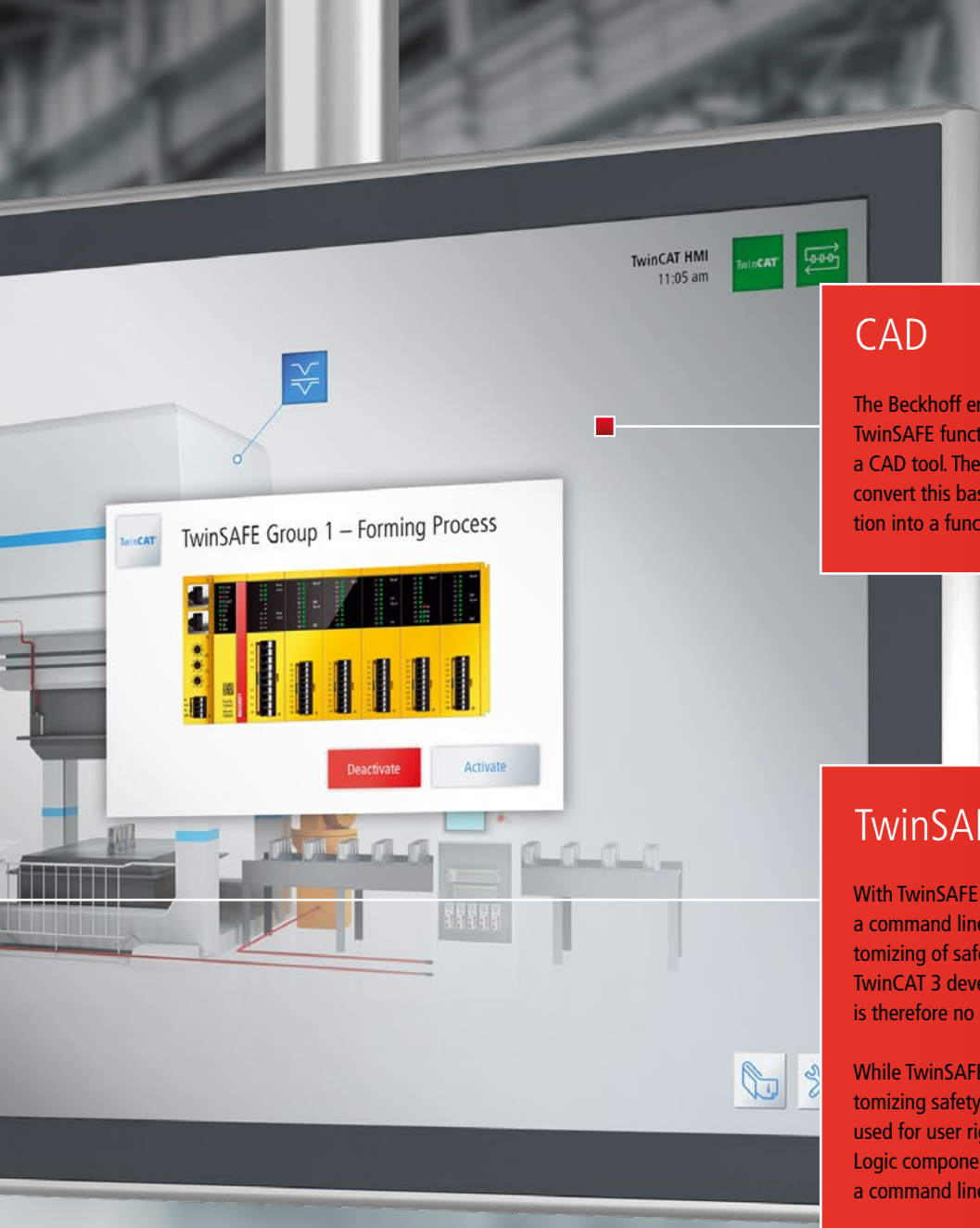

CAD

The Beckhoff engineering provides tools that allow the TwinSAFE functionality to be configured directly within a CAD tool. The AML interchange format can be used to convert this basic implementation of the safety application into a functional TwinCAT 3 project.

TwinSAFE Loader/User

With TwinSAFE Loader, the Beckhoff engineering provides a command line tool, which allows downloading and customizing of safety projects at runtime. Explicit use of the TwinCAT 3 development environment for this application is therefore no longer necessary with this tool.

While TwinSAFE Loader is used for downloading and customizing safety projects, the TwinSAFE User tool can be used for user rights administration regarding TwinSAFE Logic components. As with TwinSAFE Loader, this tool is a command line tool.

TwinSAFE Loader

The TwinSAFE Loader is a command line tool that allows a safety project to be customized without TwinCAT 3. For example, modules can be activated and deactivated directly via a custom HMI. On one hand, this means that the TwinSAFE system can be optimally adapted to customer-specific processes. On the other hand, common use cases, such as the commissioning process, can be simplified considerably. With customizing, individual modules of the safety application can be temporarily deactivated for commissioning machine parts and then subsequently reactivated without having to

perform renewed validation and verification of the entire safety application.

Flexibility in application and tooling:

- highly flexible modularisation during runtime through customizing
- preconfiguration of safety applications within CAD tool
- TwinSAFE Loader and TwinSAFE User are user-friendly tools for series production
- TwinSAFE Loader enables modularisation during runtime without the use of TwinCAT 3

At a glance: the TwinSAFE software workflow

Development

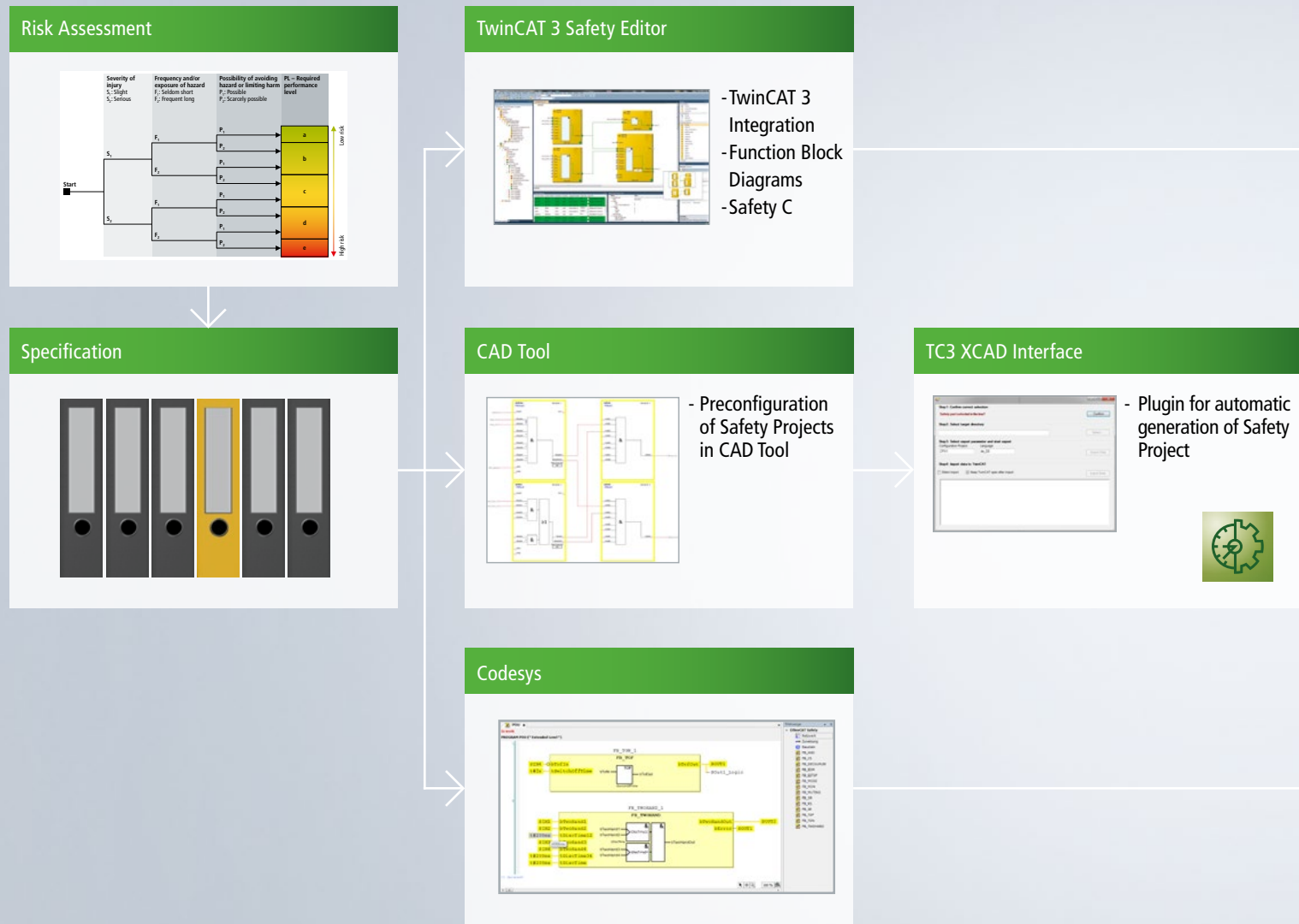

TwinCAT 3 and TwinCAT 2

In the Beckhoff world, a safety application can be implemented either with TwinCAT 2 or 3. Whereas TwinCAT 2 can be used exclusively for the TwinSAFE Logic components EL6900, EL6930 and KL6904, all Logic components with the exception of the KL6904 can be configured with TwinCAT 3.

TC3 XCAD Interface

Beckhoff provides the possibility to create a safety application directly within a CAD tool. With the help of the TC3 XCAD Interface, the application can subsequently be converted into

a fully functional safety project in TwinCAT 3 to undergo final configuration.

Codesys

As an option, the Beckhoff TwinSAFE Logic components can be configured using Codesys Safety.

TwinSAFE Loader

The TwinSAFE Loader tool offers a possibility to download a safety project entirely without the TwinCAT engineering environment. It is a command line tool that can be integrated into customer-specific processes. It enables, for example, the loading of TwinSAFE Logic

Deployment

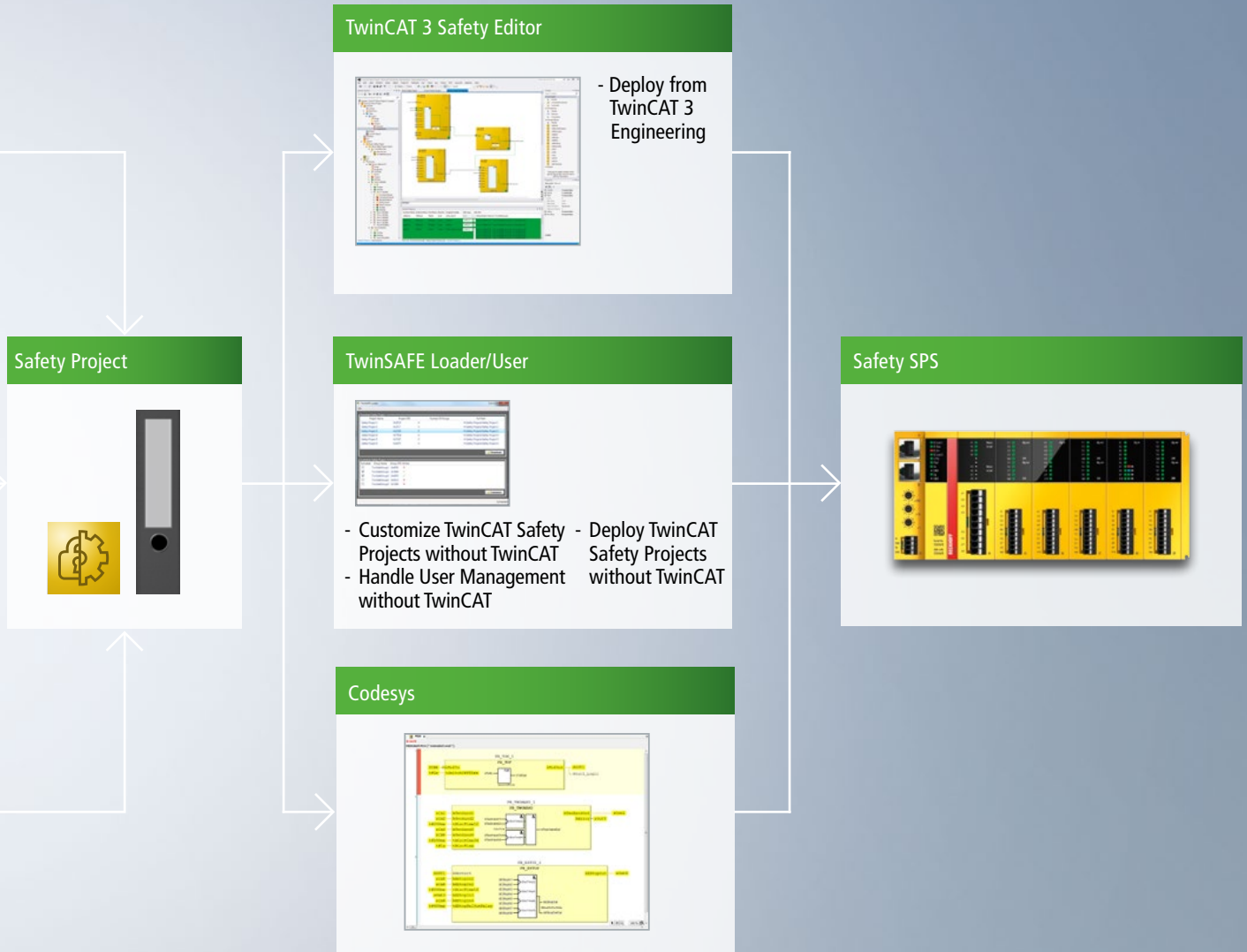

components during series production without the use of a development environment. Furthermore, TwinSAFE Loader enables an existing system to be customized at runtime. When using TwinSAFE Loader in the context of customer-specific processes, the FMEDA method for risk analysis given in the user manual must always be observed.

TwinSAFE User

The TwinSAFE User tool can be used to handle the user administration for a TwinSAFE Logic component. It enables, e.g., to configure the user administration for accessing a TwinSAFE Logic

component during series production, without using a development environment.

Flexible workflow support:

- comprehensive support during the engineering process
- free choice of development tool
- various deployment possibilities for different requirements

Simplified implementation: the application manual

Collection of safety functions

BECKHOFF New Automation Technology Circuit examples

2.14 Light grid (Category 4, PL e)

The light grid has two OSSD outputs (Output-Signal-Switching-Devices), which are wired to safe inputs of an EL1904. The testing of the inputs is not active, since the OSSD outputs carry out their own test. Furthermore, the signals are checked for discrepancy (200 ms). The feedback loop is read in via a safe input. Testing is active for this input. The contactors K1 and K2 are connected in parallel to the safe output. Current measurement and testing of the output are active for this circuit.

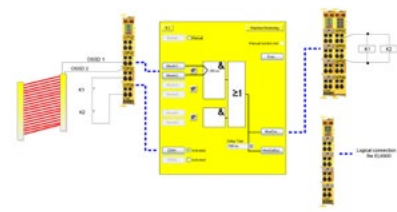

2.14.1 Parameters of the safe input and output terminals

EL1904	
Parameter	Value
Sensor test channel 1 active	No
Sensor test channel 2 active	No
Sensor test channel 3 active	Yes
Sensor test channel 4 active	Yes
Logic channel 1 and 2	Asynchronous evaluation OSSD
Logic channel 3 and 4	Single Logic

EL2904	
Parameter	Value
Current measurement active	Yes
Output test pulses active	Yes

Application Guide TwinSAFE - version 1.9.1 89

Every safety function is described in detail including the specific parametrisation of TwinSAFE components.

Block formation and output parameters

Circuit examples BECKHOFF New Automation Technology

2.14.2 Block formation and safety loops

2.14.2.1 Safety function 1



2.14.3 Calculation

2.14.3.1 PFH / MTTFa / B10u - values

Component	Value
EL1904 - PFH	1.11E-09
EL2904 - PFH	1.25E-09
EL8900 - PFH	1.03E-09
Light grid - PFHs	1.50E-08
K1 - B10u	1,300,000
K2 - B10u	1,300,000
Days of operation (da)	230
Hours of operation / day (ha)	16
Cycle time (minutes) (Tcycle)	5 (12x per hour)
Lifetime (T1)	20 years = 175200 hours

The block circuit diagram and the output parameters used are listed for every safety function.

Calculation of safety parameters

$$MTTF_e(EL1904) = \frac{(1 - DC(EL1904))}{PFH(EL1904)} = \frac{(1 - 0,99)}{1,11E - 09 \frac{1}{h} \cdot 8760 \frac{h}{y}} = \frac{0,01}{9,72E - 06 \frac{1}{y}} = 1028,8y$$

$$MTTF_e(EL6900) = \frac{(1 - DC(EL6900))}{PFH(EL6900)} = \frac{(1 - 0,99)}{1,03E - 09 \frac{1}{h} \cdot 8760 \frac{h}{y}} = \frac{0,01}{9,02E - 06 \frac{1}{y}} = 1108,6y$$

$$MTTF_e(EL2904) = \frac{(1 - DC(EL2904))}{PFH(EL2904)} = \frac{(1 - 0,99)}{1,25E - 09 \frac{1}{h} \cdot 8760 \frac{h}{y}} = \frac{0,01}{1,1E - 05 \frac{1}{y}} = 913,2y$$

$$MTTF_e(\text{Light grid}) = \frac{(1 - DC(\text{Light grid}))}{PFH(\text{Light grid})} = \frac{(1 - 0,99)}{1,50E - 08 \frac{1}{h} \cdot 8760 \frac{h}{y}} = \frac{0,01}{1,31E - 04 \frac{1}{y}} = 76,1y$$

$$MTTF_{Dges} = \frac{1}{\frac{1}{76,1y} + \frac{1}{1028,8y} + \frac{1}{1108,6y} + \frac{1}{913,2y} + \frac{1}{294,4y}} = 51,3y$$

$$DC_{avg} = \frac{\frac{99\%}{76,1} + \frac{99\%}{1028,8} + \frac{99\%}{1108,6} + \frac{99\%}{913,2} + \frac{99\%}{588,7} + \frac{99\%}{294,4}}{\frac{1}{76,1} + \frac{1}{1028,8} + \frac{1}{1108,6} + \frac{1}{913,2} + \frac{1}{588,7} + \frac{1}{294,4}} = 99,0\%$$

The calculation of safety parameters is explained transparently and in detail for every safety function to enable easy adjustment to any modified usage of the safety function.

Identification of safety category

Designation for each channel	MTTF _e	Range for each channel
low		3 years ≤ MTTFe < 10 years
medium		10 years ≤ MTTFe < 30 years
high		30 years ≤ MTTFe ≤ 100 years

Designation	DC _{avg}	Range
none		DC < 60 %
low		60 % ≤ DC < 90 %
medium		90 % ≤ DC < 99 %
high		99 % ≤ DC

Category	B	1	2	2	3	3	4
DC	none	none	low	medium	low	medium	high
low	a	-	a	b	b	c	-
medium	b	-	b	c	c	d	-
high	-	c	c	d	d	d	e

Detailed description for determining the correct safety category.

Application manual

To simplify the design of safety functions, Beckhoff has made the TwinSAFE application manual available for download via the company website. The user-friendly manual contains a compilation of sample applications for TwinSAFE with a collection of widely used safety functions. Each sample shows the interconnection of the hardware components and the corresponding mapping inside the safety application itself, i.e. the implementation with the help of pre-certified function blocks and the parameterisation of input and output components. For further support the verification of the respective safety level as

confirmed by the TÜV SÜD authority is executed for each sample, so that the samples can either be adopted 1:1 or adapted very simply to specific application requirements.

Comprehensive support in conceptual design and implementation:

- continuously expanded collection of relevant application examples
- best-possible support to enable correct implementation of safety applications
- simple adaptation to modified applications through detailed documentation of the safety acceptance

Highly modular: the TwinSAFE product portfolio

Input, Logic and Output

EL2911 EtherCAT Terminal, 4-channel digital input, 1-channel digital output, 24 V DC, $I_{max} = 10\text{ A}$

EL1957 EtherCAT Terminal, 8-channel digital input, 4-channel digital output, 24 V DC, $I_{max} = 0.5\text{ A}$

EP1957 EtherCAT Box, 8-channel digital input, 4-channel digital output, 24 V DC, $I_{max} = 0.5\text{ A}$

EJ1957 EtherCAT plug-in module, 8-channel digital input, 4-channel digital output, 24 V DC, $I_{max} = 0.5\text{ A}$

EK1960 TwinSAFE Compact Controller
20 safe inputs, 24 safe outputs,
optionally 4 relay outputs

AX81xx-0100 Drive with TwinSAFE option, 1 axis

AX82xx-0100 Drive with TwinSAFE option, 2 axes

Input and Logic



EL1918 EtherCAT Terminal, 8-channel digital input, 24 V DC

EP1918 EtherCAT Box, 8-channel digital input, 24 V DC

EJ1914 EtherCAT plug-in module, 4-channel digital input, 24 V DC

EJ1918 EtherCAT plug-in module, 4-channel digital input, 24 V DC

Input

TwinSAFE

EL1904 EtherCAT Terminal, 4-channel digital input, 24 V DC

EK1914 EtherCAT Coupler with integrated digital standard and safety I/Os:
2 safe inputs, 2 safe outputs, 4 standard inputs, 4 standard outputs, $I_{max} = 0.5\text{ A}$

EP1908-0002 EtherCAT Box, 8-channel digital input, 24 V DC

KL1904 Bus Terminal, 4-channel digital input, 24 V DC

TwinSAFE SC (selection)

EL3124-0090 EtherCAT Terminal, 4-channel analog input, 4...20 mA, differential input, 16 bit

EL3314-0090 EtherCAT Terminal, 4-channel input, thermocouple with wire breakage detection

EL5021-0090 EtherCAT Terminal, 1-channel SinCos encoder interface, 1 V_{pp}

EP3174-0092 EtherCAT Box, 4-channel analog input, ±10 V or 0/4...20 mA, differential input, 16 bit

Dedicated Logic

Engineering with FBD

EL6910 EtherCAT Terminal, TwinSAFE Logic

EL6900 EtherCAT Terminal, TwinSAFE Logic

EL6930 EtherCAT Terminal, TwinSAFE Logic, with PRO

EJ6910 EtherCAT plug-in module, TwinSAFE Logic

Engineering with Safety C

TwinCAT Safety PLC software-based
safety controller

For detailed information on our products please see here ► www.beckhoff.com/TwinSAFE





Logic and Output



- EL2912** EtherCAT Terminal, 2-channel digital output, 24 V DC, $I_{max} = 2.3$ A
- EJ2914** EtherCAT plug-in module, 4-channel digital output, 24 V DC, $I_{max} = 0.5$ A
- EJ2918** EtherCAT plug-in module, 8-channel digital output, 24 V DC, $I_{max} = 0.5$ A
- KL6904** Bus Terminal, 4-channel digital output, 24 V DC, $I_{max} = 0.5$ A



DFIsafe gateway

Output

I/O

- EL2904** EtherCAT Terminal, 4-channel digital output, 24 V DC, $I_{max} = 0.5$ A
- EK1914** EtherCAT Coupler with integrated digital standard and safety I/Os:
2 safe inputs, 2 safe outputs, 4 standard inputs, 4 standard outputs, $I_{max} = 0.5$ A
- KL2904** Bus Terminal, 4-channel digital output, 24 V DC, $I_{max} = 0.5$ A

Motion

- AX5000** Digital Compact Servo Drives
- AX5801-0200** TwinSAFE drive option card, up to 40 A, STO, SS1
- AX5805-0000** TwinSAFE drive option card, up to 40 A, STO, SS1, SS2, SOS, SLS, SDI
- AX5806-0000** TwinSAFE drive option card, up to 60 A, STO, SS1, SS2, SOS, SLS, SDI

Globally available: Beckhoff safety expertise



- Headquarters
- Subsidiary
- Headquarters distributor

Beckhoff – New Automation Technology
 Beckhoff implements open automation systems based on PC Control technology for more than 35 years. The product range covers Industrial PCs, I/O and Fieldbus Components, Drive Technology and automation software. For all areas of application, product series are available that can be used as separate components or integrated into a complete and seamless control system.

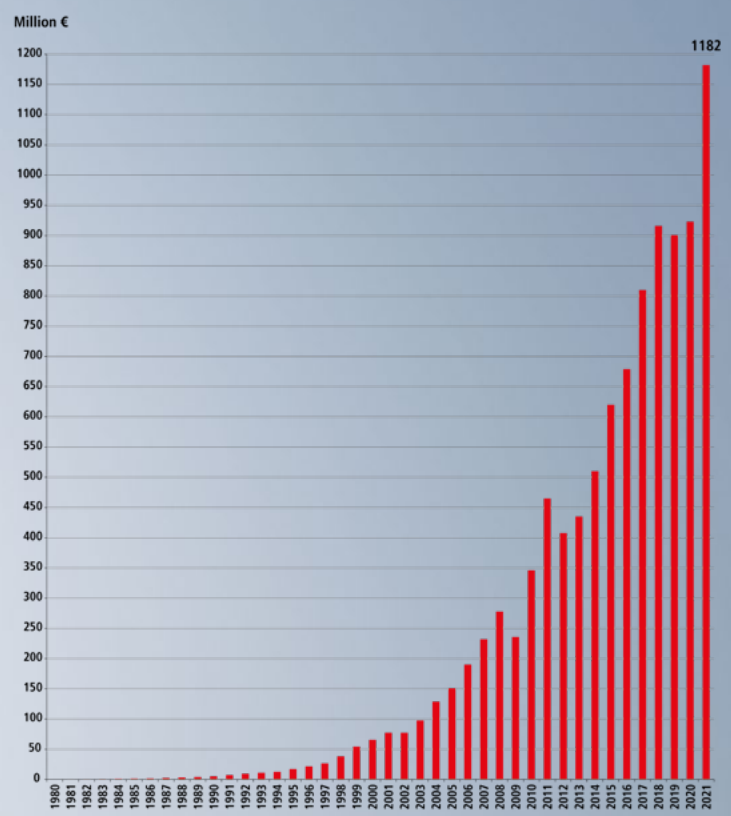

Sales development

The Beckhoff “New Automation Technology” philosophy represents innovative control and automation solutions that are used worldwide in a wide variety of different applications and industries, ranging from CNC-controlled machine tools and wind turbines to intelligent building automation.

Worldwide presence on all continents
 The worldwide presence of Beckhoff in 75 countries ensures fast service and support for globally operating customers in their local language. Moreover, geographical proximity helps us develop an in-depth understanding of the technical challenges our customers are faced with around the world.

- Beckhoff at a glance**
- headquarters in Verl, Germany
 - 1182 billion euros in global sales in 2021
 - 5000 employees worldwide
 - 1900 engineers
 - 40 subsidiaries/representative offices worldwide
 - 24 branch offices in Germany
 - more than 75 distributors worldwide
- (Status: March 2022)

▶ www.beckhoff.com

Integrate your winning edge
in safety with PC-based control:
► www.beckhoff.com/twinsafe

Beckhoff Automation GmbH & Co. KG

Hülshorstweg 20

33415 Verl

Germany

Phone: + 49 5246 963-0

info@beckhoff.com

www.beckhoff.com

Beckhoff®, TwinCAT®, EtherCAT®, EtherCAT G®, EtherCAT G10®, EtherCAT P®, Safety over EtherCAT®, TwinSAFE®, XFC®, XTS® und XPlanar® are registered trademarks of and licensed by Beckhoff Automation GmbH. Other designations used in this publication may be trademarks whose use by third parties for their own purposes could violate the rights of the owners.

© Beckhoff Automation GmbH & Co. KG 08/2022

The information provided in this brochure contains merely general descriptions or characteristics of performance which in case of actual application do not always apply as described or which may change as a result of further development of the products. An obligation to provide the respective characteristics shall only exist if expressly agreed in the terms of contract.